

FC-35 Reducer System Chart

(FC-100DF • FS-102 • FC-100)

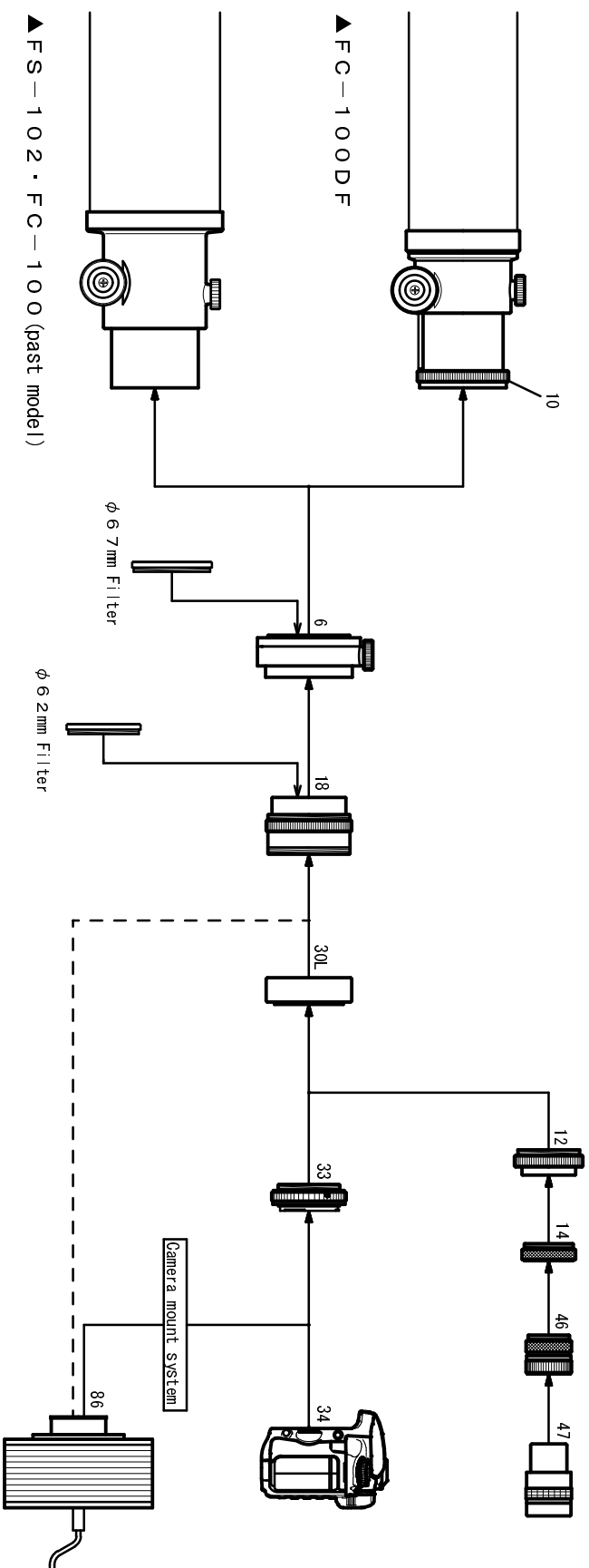

▲FS-102 • FC-100 (past model)

- | | | | |
|-----------------------------------|------------|-----------------------------|------------|
| 6. GAA (TSA-102) | [TKA23200] | 33. T-mount DX-WR (EOS) | [TKA01251] |
| 10. F-50. 8AD | [TKP19001] | T-mount DX-WR (Nikon) | [TKA01255] |
| 12. Eyepiece adapter (CGA-250) | [TKP86005] | 34. DSLR | |
| 14. Eyepiece adapter coupling (S) | [TKP00103] | 46. Eyepiece adapter (31.7) | [TKP00101] |
| 18. FC-35 Reducer 0.66x | [TKA19580] | | |
| 30L. GA Ring 100 | [TKA19202] | 86. CGD | |

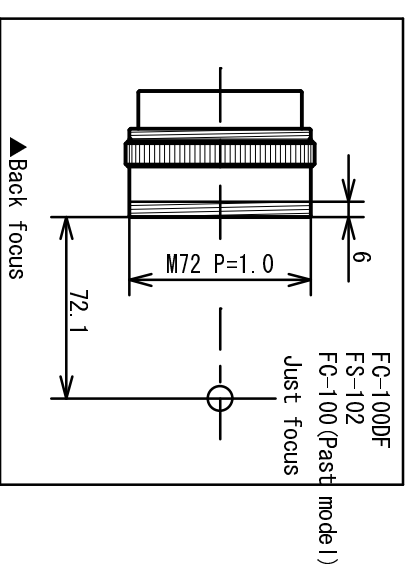

FC-35 Reducer System Chart

(FS-128 • FC-152 • FC-125)

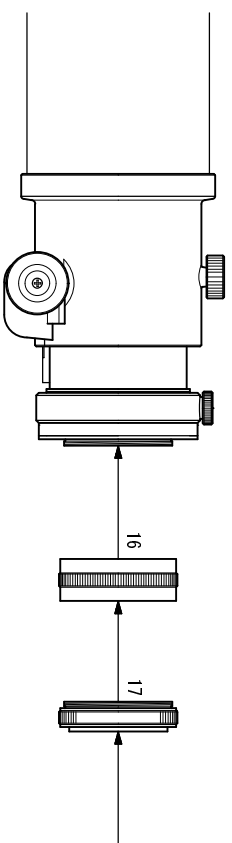

▲FS-128 • FC-125

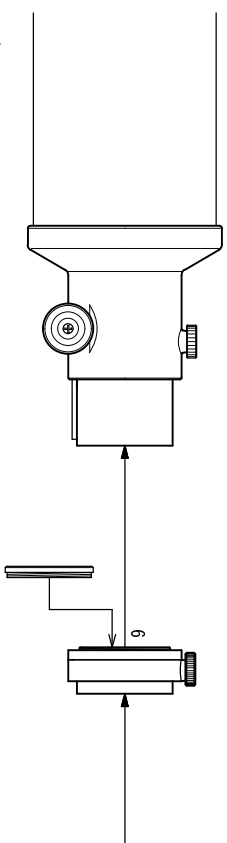

▲FS-128N • FC-125N

φ6.7mm Filter

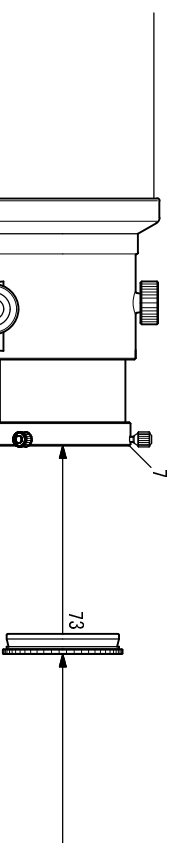

▲FS-128F • FS-152

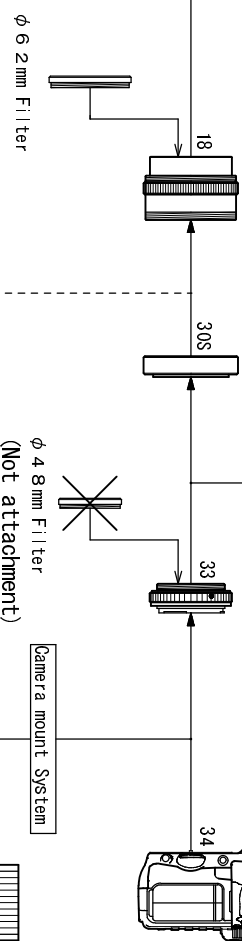
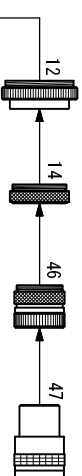

φ4.8mm Filter
(Not attachment)

- 6. CAA(TSA-102) [TKA23200]
- 7. Coupling (DT) (FS-152) [TKP27001]
- 12. Visual Adapter (CGA-250) [TKP86005]
- 14. Eye-piece adapter coupling(S) [TKP00103]
- 16. Specer ring (FC-125)
- 17. Eye-piece coupling (FC-125)
- 18. FC-35 Reducer 0.66x [TKA19580]

- 30S. CA Ring 130 [TKA31202]
- 33. T-mount DX-WR (EOS) [TKA01251]
- T-mount DX-WR (Nikon) [TKA01255]
- 34. DSLR [TKP00101]
- 46. Eye-piece adapter 31.7 [TKP00101]
- 47. Eye-piece 31.7 [TKP27113]
- 73. φ8.9 Tapered ring [TKP27113]
- 86. CCD

